



# SL Plus Tank Level Monitor System Calibration Instructions

## Note:

This calibration procedure must be performed to ensure that the indicated fluid levels on the display accurately match the actual levels in the tank. The tank can be full or empty to begin calibration, but must be filled before beginning Step 3. To ensure proper calibration, do not have water in the fill tower and perform calibration with the apparatus on a level surface.

### Step 1: Initiate Calibration

Within 1 min. of powering up the unit, place the magnet over the master display horizontally (as shown) between the row of Red and Amber LEDs.

The different color level LEDs will flash in succession and then they will flash on/off together - at the same time.

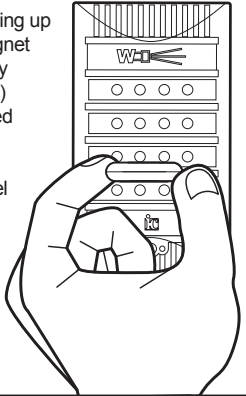

### Step 2: Calibrating The Probe

With all the display LEDs flashing, fill the tank, if not already full.

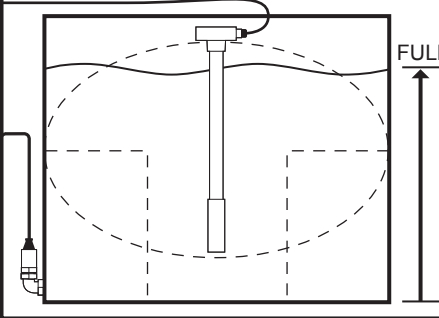

### Step 3: Tank Selection Mode

Place the magnet over the display between Red and Amber levels. The lights will flash in sequence upward beginning the tank selection mode.

You will now select the tank shape. For a rectangular tank, go to Step 4. For a T tank, go to Step 5. For an elliptical tank go to Step 6.

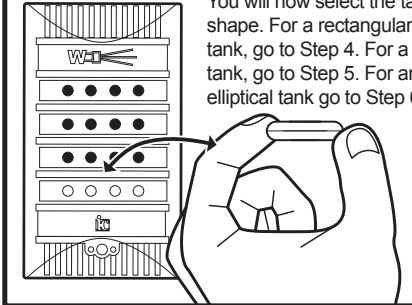

### Step 4: Rectangular Tank

When the Red LEDs begin to flash, place the magnet back onto the master display before the lights flash for the fifth time. Remove the magnet.

Calibration for a rectangular tank is now complete. If the magnet is not placed in time, wait until tank shape sequence begins again.

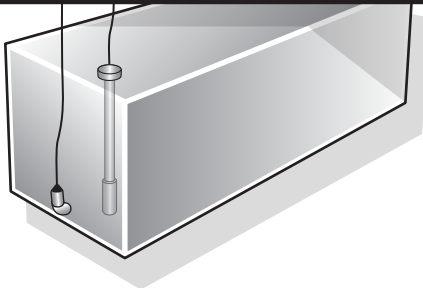
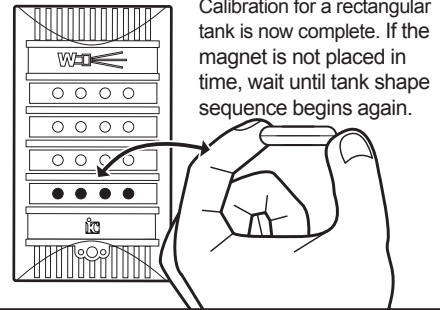

### Step 5: T-Shaped Tank

When the Amber LEDs begin to flash, place the magnet back onto the master display before the lights flash for the fifth time. Remove the magnet.

Calibration for a T-shaped tank is now complete. If the magnet is not placed in time, wait until tank shape sequence begins again.

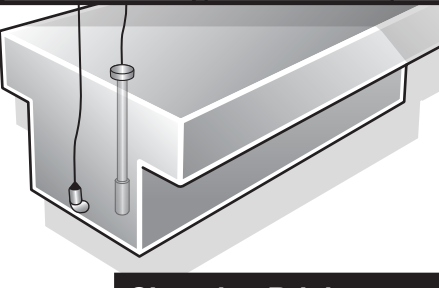
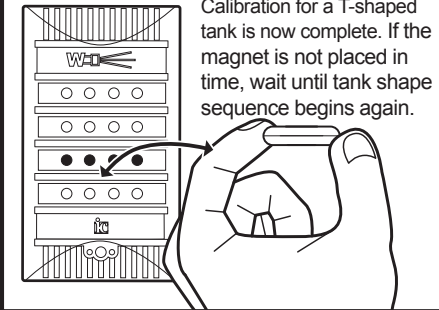

### Step 6: Elliptical Tank

When the Blue LEDs begin to flash, place the magnet back onto the master display before the lights flash for the fifth time. Remove the magnet.

Calibration for an elliptical tank is now complete. If the magnet is not placed in time, wait until tank shape sequence begins again.

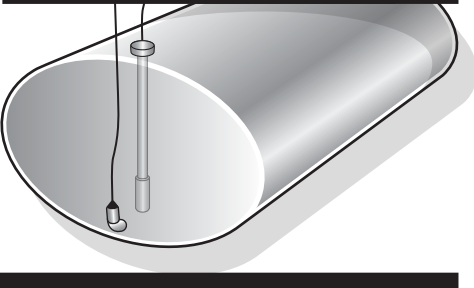
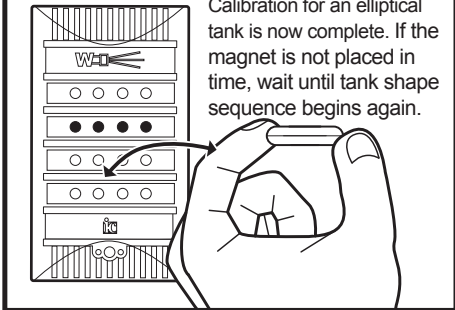

## Note:

If the magnet is not placed in front of the display to select a tank shape, the tank selection sequence will continue and the Green LEDs will flash 5 times. This Green LED sequence is for Manual Tank Calibration (see back of page).

After the Green LEDs flash 5 times, the tank shape selection sequence will begin again. (Step 4) The tank shape selection sequence will repeat 3 times. If no tank shape selection is made in this time, the display will default to a rectangular tank.

If the display was calibrated incorrectly, remove power from the display and repeat the process. Recalibration will not occur without cycling power.

### Changing Brightness

The display has 3 brightness levels. The factory default is set to Medium. When the unit is powered-up, the two middle rows of LEDs (Blue and Amber) will quickly flash twice, indicating this Medium setting. To change the setting to low, hold a magnet over the opening below the logo area of the display. The bottom two rows of LEDs (Amber and Red) will light. When the magnet is removed, the LEDs will be set to Low brightness. If the magnet is reapplied to the sensor, the top two rows of LEDs (Green and Blue) will illuminate. When the magnet is removed, the LEDs will be set to High brightness. Placing and removing the magnet will cycle through all 3 settings

